

DESCRIPTION

The MX8806B uses advanced trench technology to provide excellent $R_{DS(ON)}$ and low gate charge. It can be used in a wide variety of applications.

GENERAL FEATURES

- $V_{DS}=18V$, $I_D=6A$
 $R_{DS(ON)}(Typ.)=17.5m\Omega$ @ $V_{GS}=2.5V$
 $R_{DS(ON)}(Typ.)=13m\Omega$ @ $V_{GS}=3.8V$
 $R_{DS(ON)}(Typ.)=12.5m\Omega$ @ $V_{GS}=4.5V$
- High Power and current handling capability
- Lead free product is acquired
- Surface Mount Package

APPLICATION

- Battery protection
- Load switch
- Power management

PINOUT

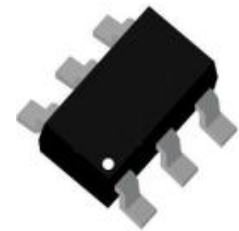
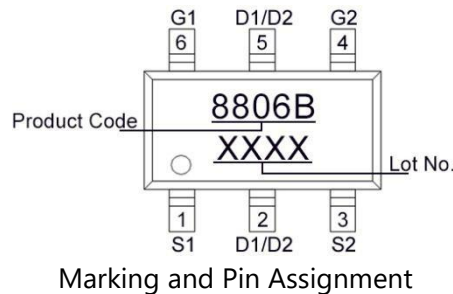
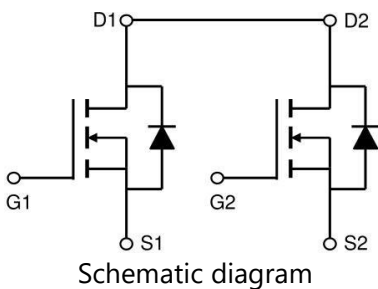

ORDERING INFORMATION

Part Number	Storage Temperature	Package	Devices Per Reel
MX8806B	-55°C to 150°C	SOT-23-6L	-

ABSOLUTE MAXIMUM RATINGS ($T_A=25^\circ C$ unless otherwise noted)

Parameter	Symbol	Limit	Unit
Drain-Source Voltage	V_{DS}	18	V
Gate-Source Voltage	V_{GS}	± 12	V
Drain Current-Continuous	I_D	6	A
Pulsed Drain Current ^(Note1)	I_{DM}	24	A
Maximum Power Dissipation	P_D	1.5	W
Operating Junction and Storage Temperature Range	T_J, T_{STG}	-55 to 150	°C

THERMAL RESISTANCE

Thermal Resistance, Junction-to-Ambient ^(Note2)	$R_{\theta JA}$	83	°C/W
--	-----------------	----	------

Note 1. Repetitive Rating: Pulse width limited by maximum junction temperature.

Note 2. Surface Mounted on FR4 Board, $t \leq 10$ sec.



ELECTRICAL CHARACTERISTICS ($T_A=25^\circ\text{C}$ unless otherwise noted)

Parameter	Symbol	Conditions	Min	Typ	Max	Unit
-----------	--------	------------	-----	-----	-----	------

Off Characteristics

Drain-Source Breakdown Voltage	BV_{DSS}	$V_{GS}=0V, I_D=250\mu A$	-	18	-	V
Zero Gate Voltage Drain Current	I_{DSS}	$V_{DS}=16V, V_{GS}=0V$	-	-	1	μA
Gate-Body Leakage Current	I_{GSS}	$V_{GS}=\pm 12V, V_{DS}=0V$	-	-	± 100	nA

On Characteristics (Note 3)

Gate Threshold Voltage	$V_{GS(th)}$	$V_{DS}=V_{GS}, I_D=250\mu A$	0.45	0.7	1	V
Drain-Source On-State Resistance	$R_{DS(on)}$	$V_{GS}=2.5V, I_D=3.5A$	16	17.5	22	m Ω
		$V_{GS}=3.8V, I_D=4A$	12	13	17	m Ω
		$V_{GS}=4.5V, I_D=4.5A$	11.5	12.5	15	m Ω
Forward Transconductance	g_{FS}	$V_{DS}=5V, I_D=6A$	-	15	-	S

Dynamic Characteristics (Note 4)

Input Capacitance	C_{iss}	$V_{DS}=10V, V_{GS}=0V, F=1.0MHz$	-	770	-	pF
Output Capacitance	C_{oss}		-	185	-	pF
Reverse Transfer Capacitance	C_{rss}		-	160	-	pF

Switching Characteristics

Turn-on Delay Time	$t_{d(on)}$	$V_{DS}=10V, R_L=1\Omega, V_{GS}=4.5V, R_G=3\Omega$	-	5.5	-	nS
Turn-on Rise Time	t_r		-	11	-	nS
Turn-Off Delay Time	$t_{d(off)}$		-	48	-	nS
Turn-Off Fall Time	t_f		-	13	-	nS
Total Gate Charge	Q_g	$V_{DS}=10V, I_D=6A, V_{GS}=4.5V$	-	11	-	nC
Gate-Source Charge	Q_{gs}		-	0.7	-	nC
Gate-Drain Charge	Q_{gd}		-	2.8	-	nC

Drain-Source Diode Characteristics

Diode Forward Voltage (Note 3)	V_{SD}	$V_{GS}=0V, I_S=1A$	-	-	1.2	V
Diode Forward Current (Note 2)	I_S		-	-	6	A

Note 2. Surface Mounted on FR4 Board, $t \leq 10$ sec.

Note 3. Pulse Test: Pulse Width $\leq 300\mu s$, Duty Cycle $\leq 2\%$.

Note 4. Guaranteed by design, not subject to product.

TYPICAL ELECTRICAL AND THERMAL CHARACTERISTICS

Figure 1. Switching Test Circuit

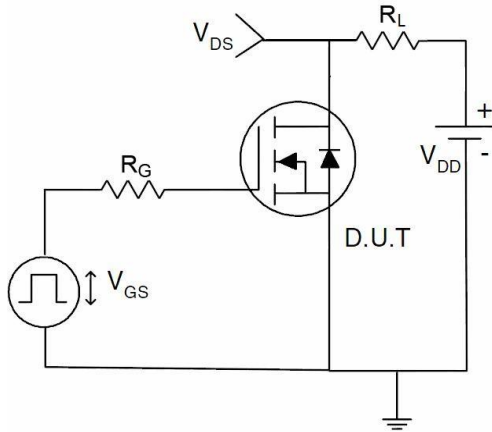

Figure 2. Switching Waveform

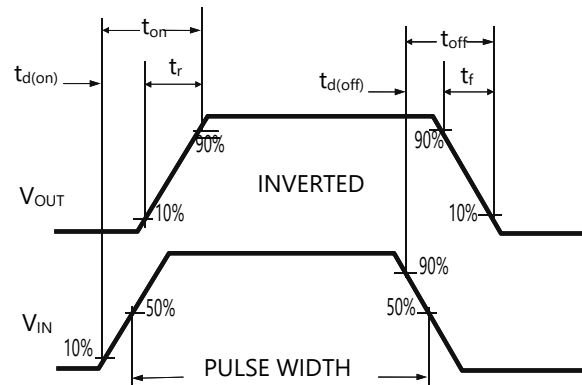

Figure 3. Power Dissipation

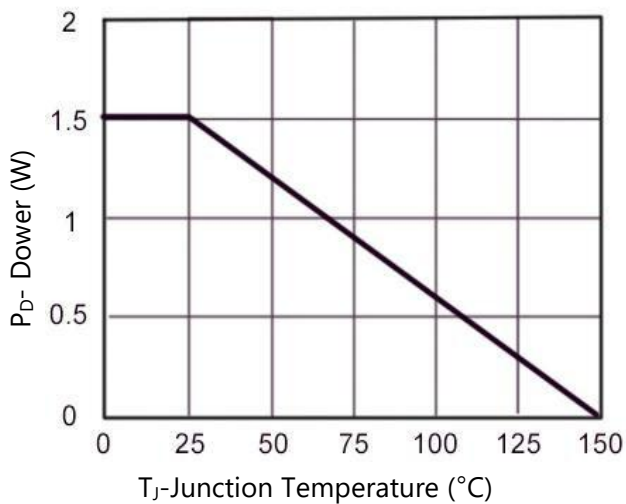

Figure 4. Drain Current

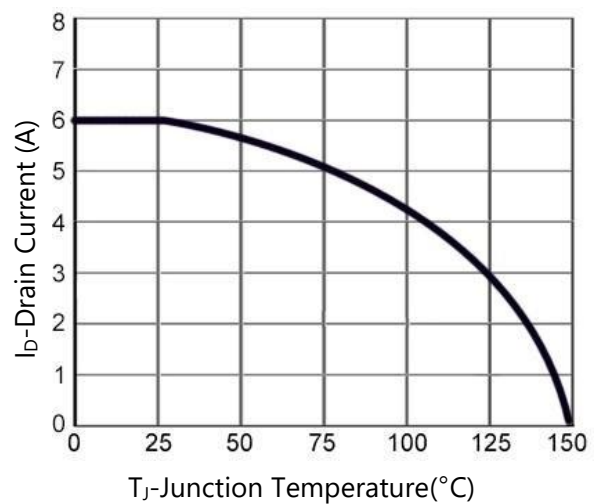

Figure 5. Output Characteristics

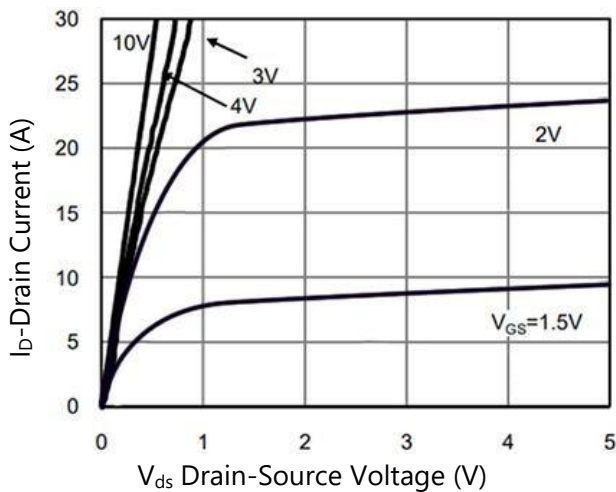
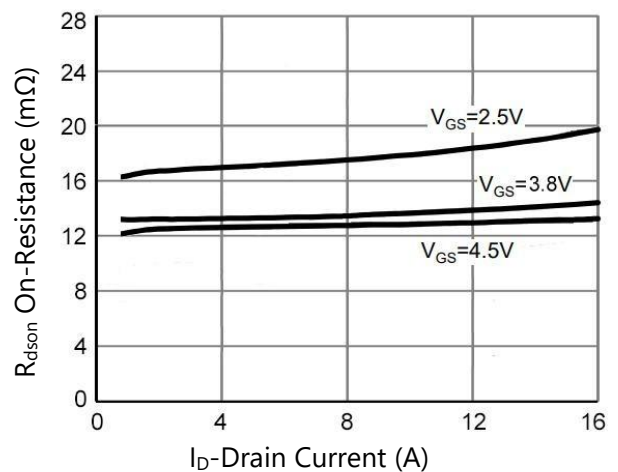

Figure 6. R_{ds(on)} vs Drain Current





TYPICAL ELECTRICAL AND THERMAL CHARACTERISTICS

Figure 7. Transfer Characteristics

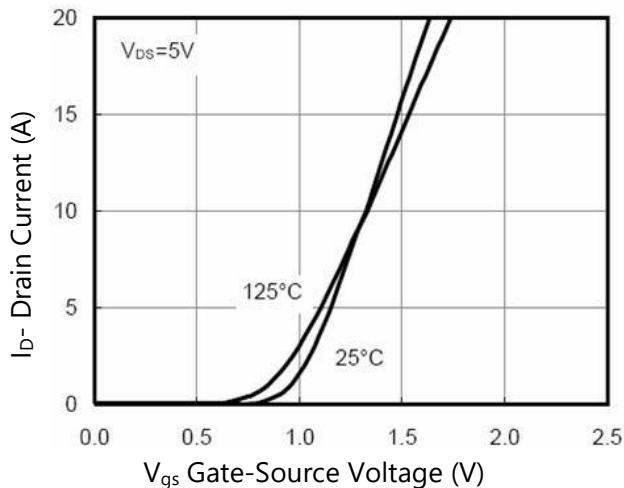

Figure 8. R_{dson} vs Junction Temperature

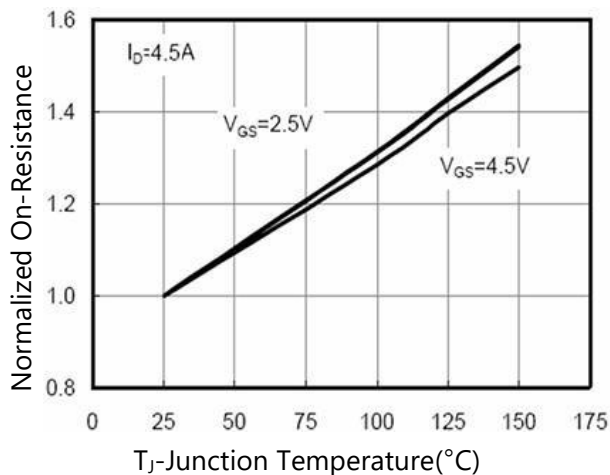

Figure 9. R_{dson} vs V_{gs}

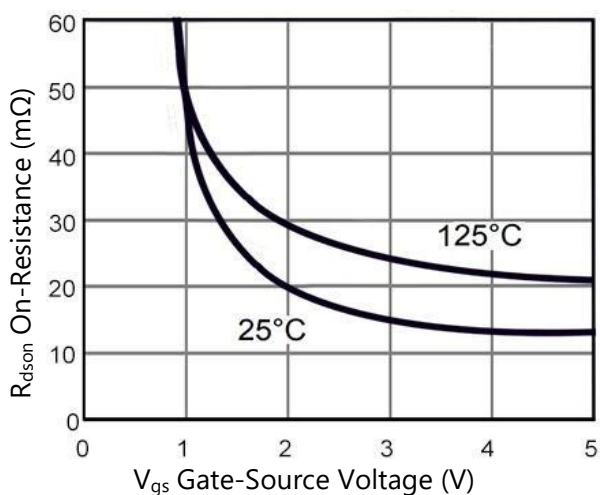

Figure 10. Capacitance vs V_{ds}

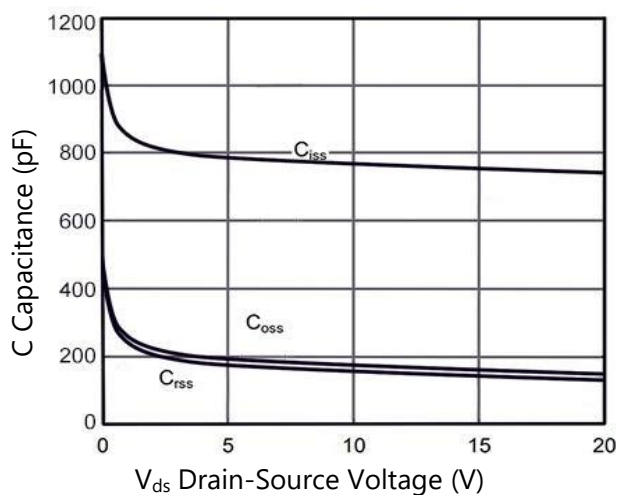

Figure 11. Gate Charge

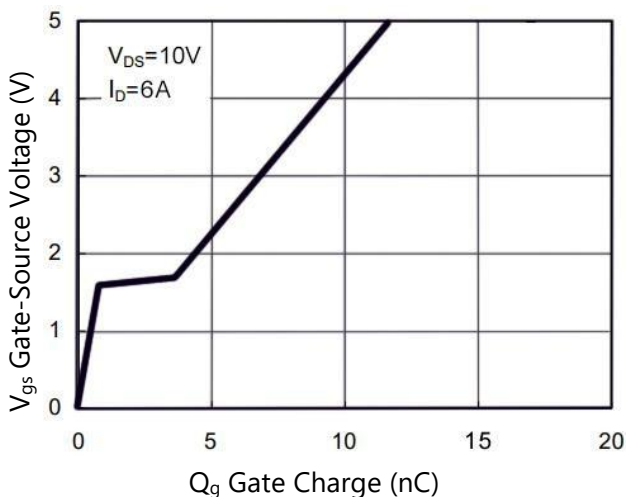
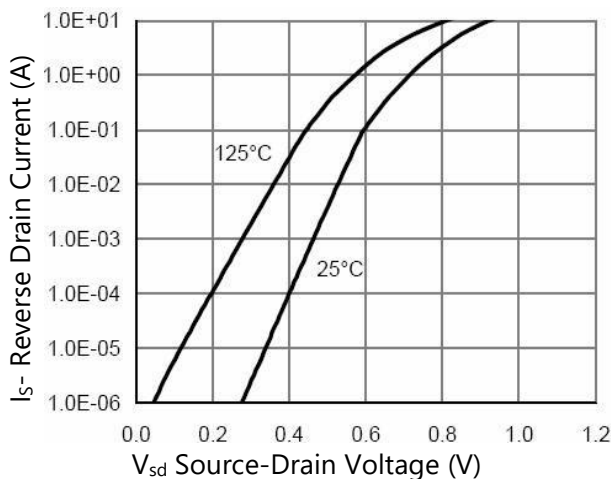

Figure 12. Source-Drain Diode Forward



TYPICAL ELECTRICAL AND THERMAL CHARACTERISTICS

Figure 13. Safe Operation Area

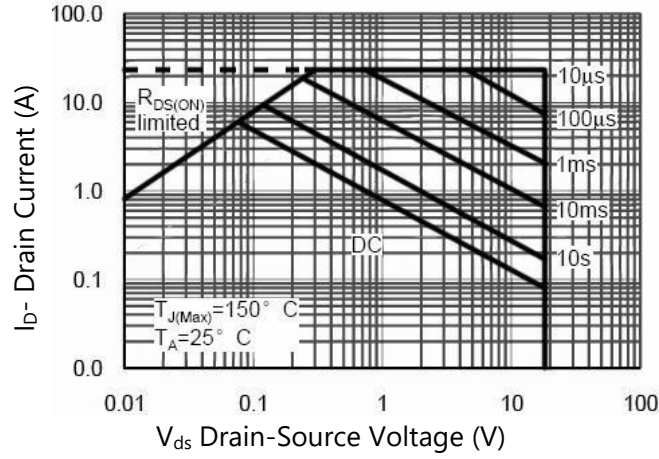
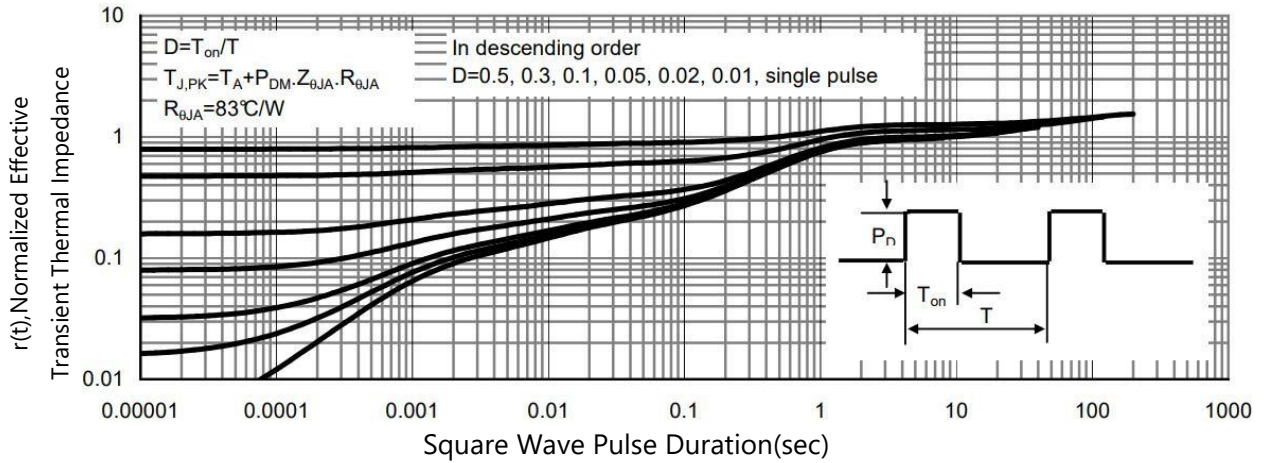
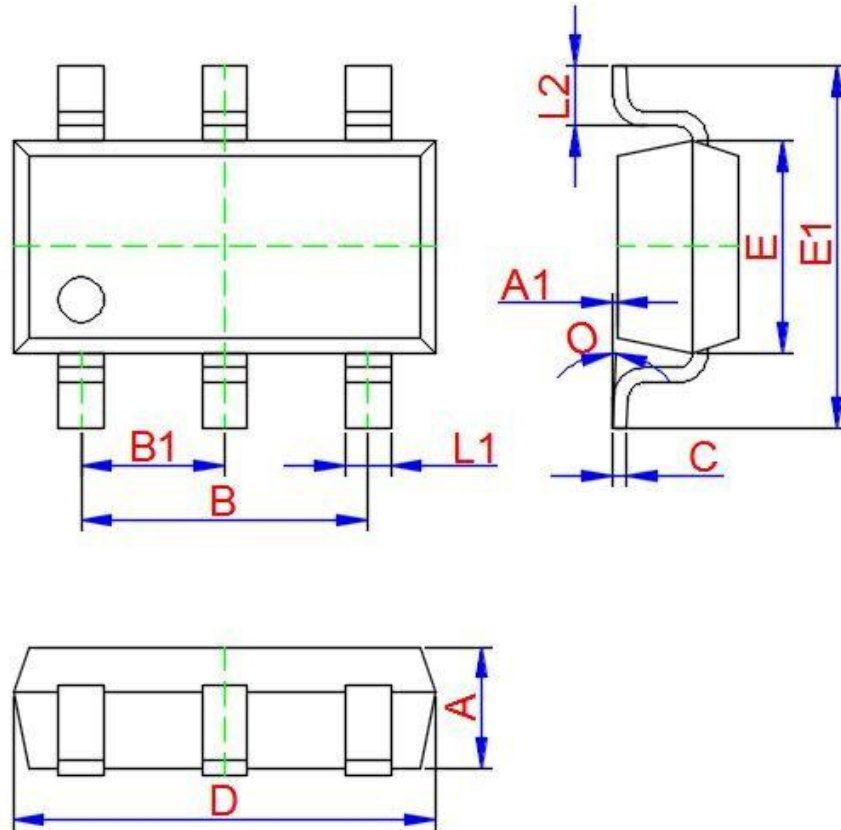

Figure 14. Normalized Maximum Transient Thermal Impedance



 **PACKAGE INFORMATION**

SOT-23-6L



Symbol	Dimensions In Millimeters		
	Min.	Typ.	Max.
A	1.050	1.100	1.150
A1	0.000	0.050	0.100
L1	0.300	0.400	0.500
C	0.100	0.150	0.200
D	2.820	2.920	3.020
E	1.500	1.600	1.700
E1	2.650	2.800	2.950
B	1.800	1.900	2.000
B1	0.950 TYP.		
L2	0.300	0.450	0.600
O	0°	4°	8°