

DESCRIPTION

The MXN2382 uses advanced trench technology to provide excellent $R_{DS(ON)}$ and low gate charge. It can be used in a wide variety of applications. It is ESD protected.

GENERAL FEATURES

- $V_{DS}=18V$, $I_D=8A$
 $R_{DS(ON)}(Typ.)=17.5m\Omega$ @ $V_{GS}=2.5V$
 $R_{DS(ON)}(Typ.)=14.5m\Omega$ @ $V_{GS}=3.1V$
 $R_{DS(ON)}(Typ.)=13m\Omega$ @ $V_{GS}=3.8V$
 $R_{DS(ON)}(Typ.)=12m\Omega$ @ $V_{GS}=4.5V$
 ESD Rating: 4000V HBM
- High Power and current handling capability
- Lead free product is acquired
- Surface Mount Package

APPLICATION

- PWM applications
- Load switch
- Power management

PINOUT

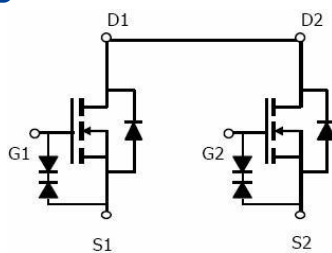

Schematic diagram

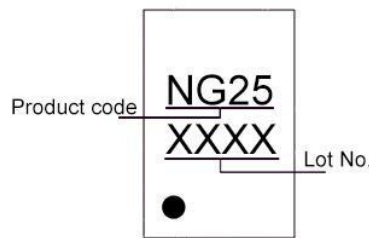

Marking and pin Assignment

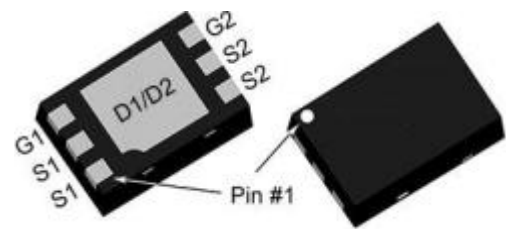

DFN2X3-6L top & bottom view

ORDERING INFORMATION

Part Number	Storage Temperature	Package	Devices Per Reel
MXN2382	-55°C to 150°C	DFN2X3-6L	-

ABSOLUTE MAXIMUM RATINGS ($T_A=25^\circ C$ unless otherwise noted)

Parameter	Symbol	Limit	Unit
Drain-Source Voltage	V_{DS}	18	V
Gate-Source Voltage	V_{GS}	± 12	V
Drain Current-Continuous	I_D	8	A
Pulsed Drain Current ^(Note1)	I_{DM}	35	A
Maximum Power Dissipation	P_D	1.25	W
Operating Junction and Storage Temperature Range	T_J, T_{STG}	-55 to 150	$^\circ C$

THERMAL RESISTANCE

Thermal Resistance, Junction-to-Ambient ^(Note2)	$R_{\theta JA}$	100	$^\circ C/W$
--	-----------------	-----	--------------

Note 1. Repetitive Rating: Pulse width limited by maximum junction temperature.

Note 2. Surface Mounted on FR4 Board, $t \leq 10$ sec.

ELECTRICAL CHARACTERISTICS ($T_A=25^\circ\text{C}$ unless otherwise noted)

Parameter	Symbol	Conditions	Min	Typ	Max	Unit
Off Characteristics						
Drain-Source Breakdown Voltage	BV_{DSS}	$V_{GS}=0V, I_D=250\mu A$	-	18	-	V
Zero Gate Voltage Drain Current	I_{DSS}	$V_{DS}=16V, V_{GS}=0V$	-	-	1	μA
Gate-Body Leakage Current	I_{GSS}	$V_{GS}=\pm 10V, V_{DS}=0V$	-	-	± 10	μA
On Characteristics ^(Note2)						
Gate Threshold Voltage	$V_{GS(th)}$	$V_{DS}=V_{GS}, I_D=250\mu A$	0.45	0.7	1.0	V
Drain-Source On-State Resistance	$R_{DS(on)}$	$V_{GS}=2.5V, I_D=5.5A$	16	17.5	22	m Ω
		$V_{GS}=3.1V, I_D=5.5A$	13	14.5	19	m Ω
		$V_{GS}=3.8V, I_D=6.5A$	12	13	17	m Ω
		$V_{GS}=4.5V, I_D=6.5A$	11	12	15	m Ω
Forward Transconductance	g_{FS}	$V_{DS}=5V, I_D=7A$	15	-	-	S
Dynamic Characteristics ^(Note3)						
Input Capacitance	C_{iss}	$V_{DS}=10V, V_{GS}=0V, F=1.0MHz$	-	760	-	pF
Output Capacitance	C_{oss}		-	205	-	pF
Reverse Transfer Capacitance	C_{rss}		-	190	-	pF
Switching Characteristics						
Turn-on Delay Time	$t_{d(on)}$	$V_{DD}=10V, I_D=2A, R_L=1\Omega, V_{GS}=4.5V, R_G=3\Omega$	-	6	-	nS
Turn-on Rise Time	t_r		-	13	-	nS
Turn-Off Delay Time	$t_{d(off)}$		-	52	-	nS
Turn-Off Fall Time	t_f		-	16	-	nS
Total Gate Charge	Q_g	$V_{DS}=10V, I_D=5A, V_{GS}=4.5V$	-	10	-	nC
Gate-Source Charge	Q_{gs}		-	1.1	-	nC
Gate-Drain Charge	Q_{gd}		-	4	-	nC
Drain-Source Diode Characteristics						
Diode Forward Voltage ^(Note2)	V_{SD}	$V_{GS}=0V, I_S=1A$	-	-	1.2	V
Diode Forward Current ^(Note1)	I_S		-	-	8	A

Note 1. Surface Mounted on FR4 Board, $t \leq 10$ sec.

Note 2. Pulse Test: Pulse Width $\leq 300\mu s$, Duty Cycle $\leq 2\%$.

Note 3. Guaranteed by design, not subject to product.

TYPICAL ELECTRICAL AND THERMAL CHARACTERISTICS

Figure 1. Switching Test Circuit

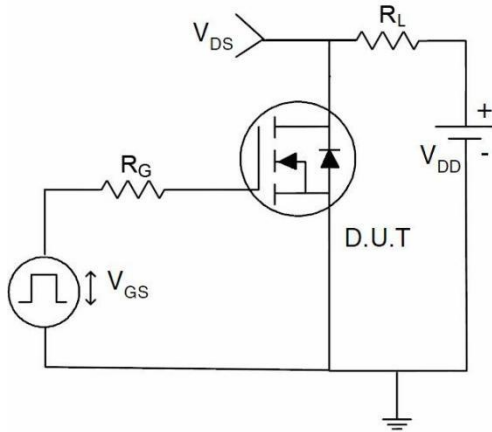

Figure 2. Switching Waveform

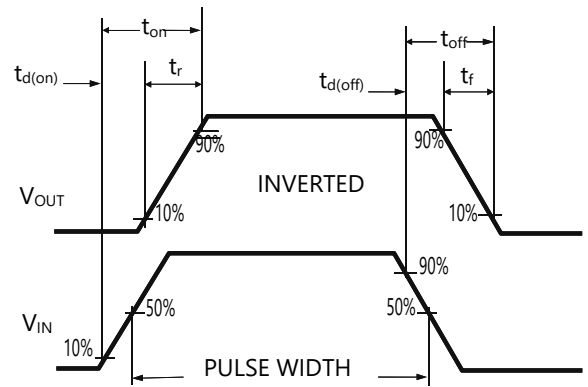

Figure 3. Power Dissipation

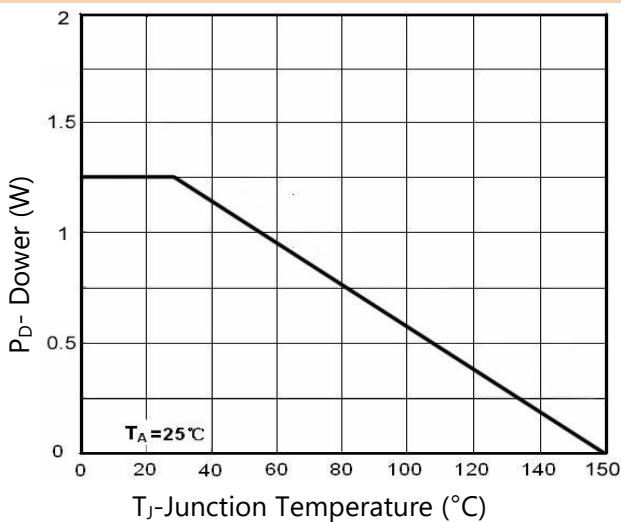

Figure 4. Drain Current

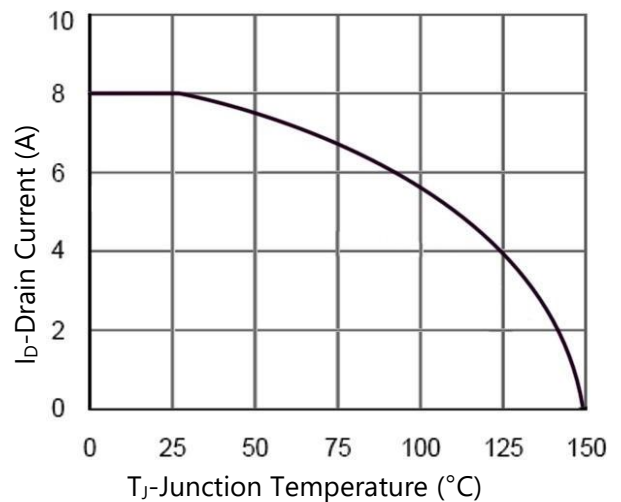

Figure 5. Output Characteristics

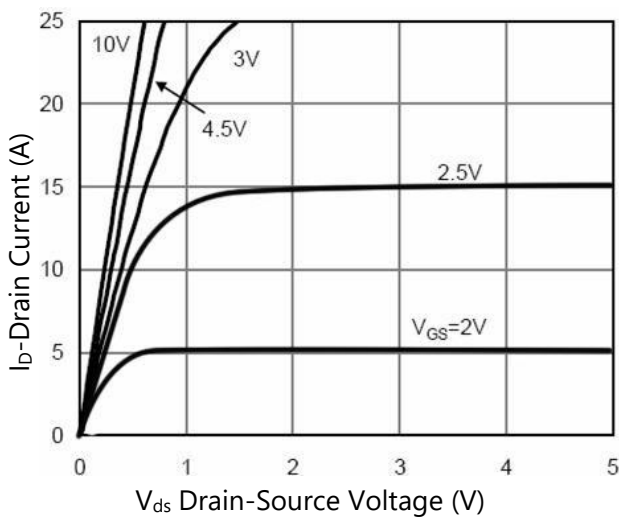
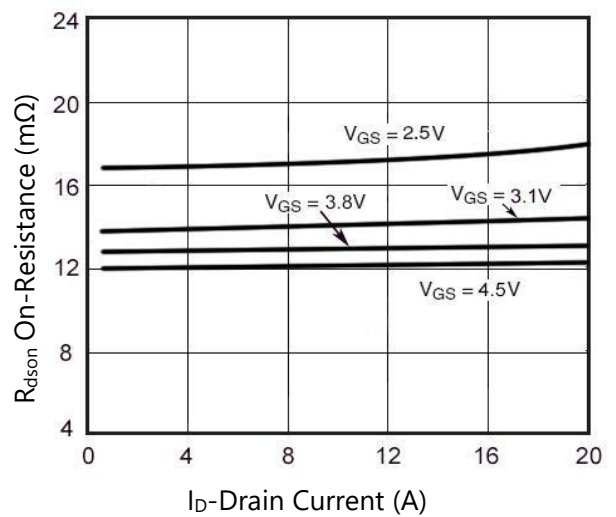

Figure 6. R_{ds(on)} vs Drain Current





TYPICAL ELECTRICAL AND THERMAL CHARACTERISTICS

Figure 7. Transfer Characteristics

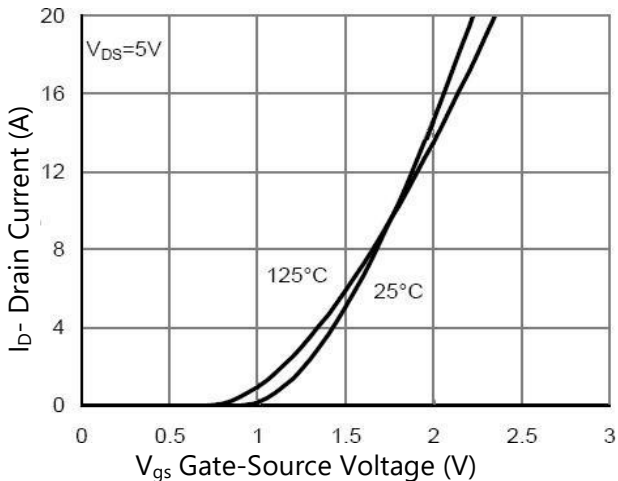

Figure 8. R_{dson} vs Junction Temperature

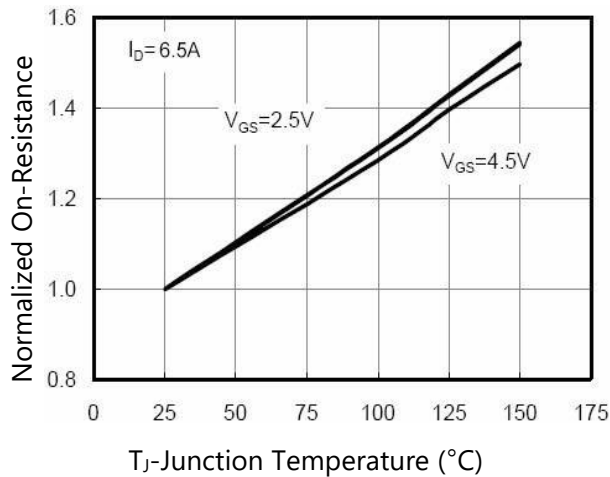

Figure 9. R_{dson} vs V_{GS}

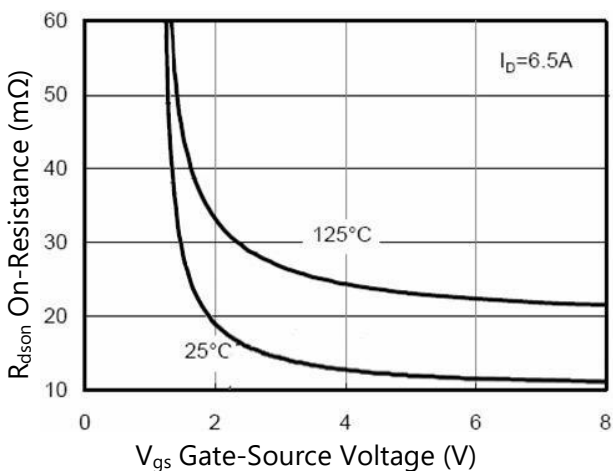

Figure 10. Capacitance vs V_{DS}

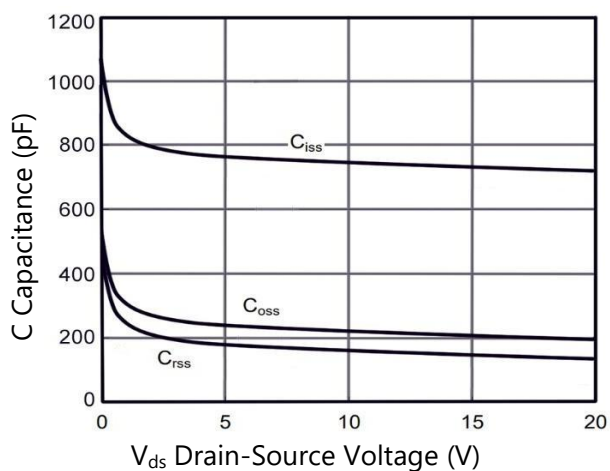

Figure 11. Gate Charge

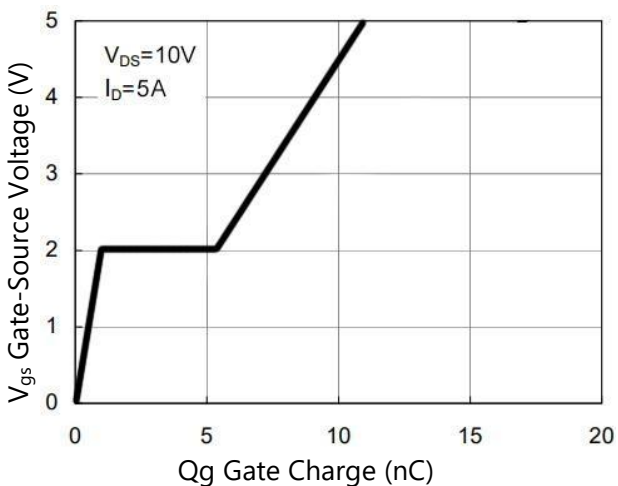
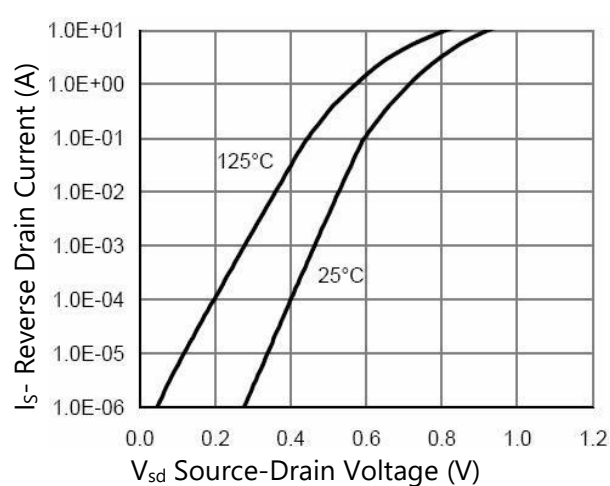

Figure 12. Source- Drain Diode Forward



TYPICAL ELECTRICAL AND THERMAL CHARACTERISTICS

Figure 13. Safe Operation Area

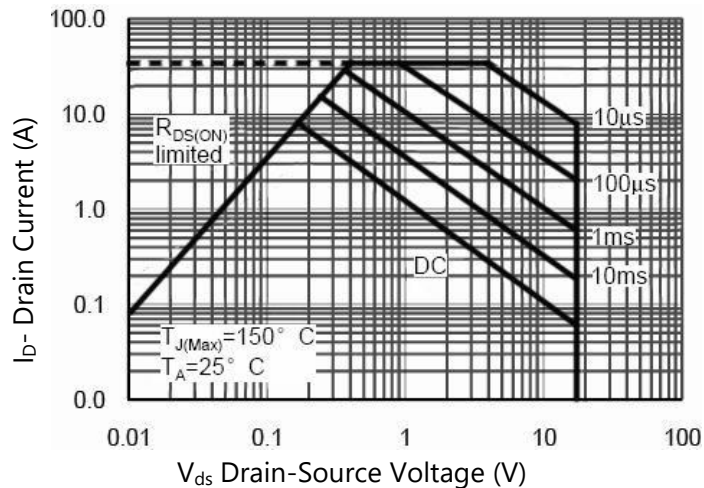
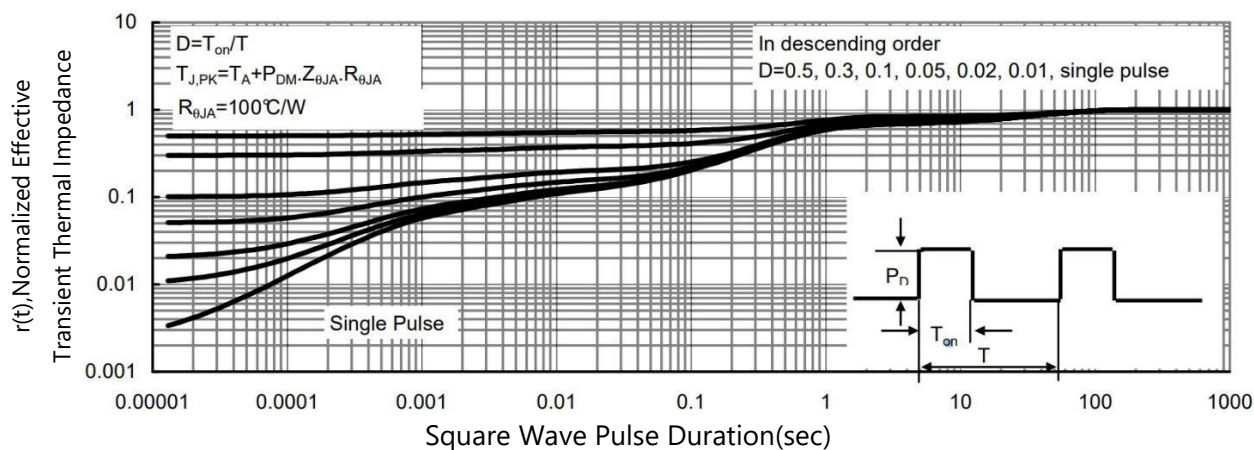
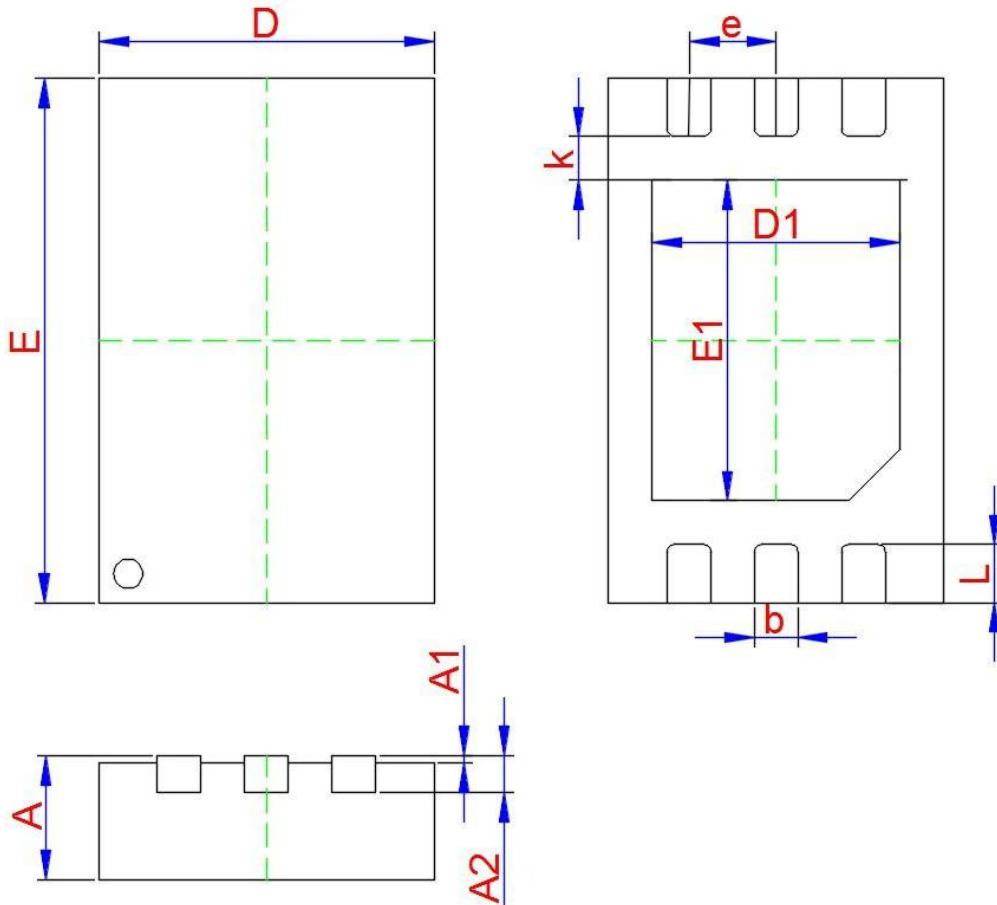

Figure 14. Normalized Maximum Transient Thermal Impedance



PACKAGE INFORMATION

DFN2X3-6L



Symbol	Dimensions in Millimeters		
	Min.	Typ.	Max.
A	0.700	0.750	0.800
A1	0.000	0.020	0.050
A2	0.203 TYP.		
D	1.950	2.000	2.050
E	2.950	3.000	3.050
D1	1.450	1.500	1.550
E1	1.650	1.700	1.750
k	0.200 MIN.		
b	0.200	0.250	0.300
e	0.500 TYP.		
L	0.300	0.350	0.400